



Guidance Document GD 11

January 2014

FIXINGS AND FASTENERS FOR RAINSCREEN SYSTEMS

INTRODUCTION

Every rainscreen or rear vented facade system is an arrangement of various layers interconnected to each other to provide the overall thermal, weathering and aesthetic appearance.

Integral to the success and the performance of rainscreen systems are the fastening components ability to resist loadings and to interconnect the component parts from the external facing materials back through the system to the structural supporting wall or framework. Maintaining the performance and transmitting the loads and resisting dead, live resistant and thermal loadings of the system are critical in the overall design and performance criteria that is essential for every rainscreen application.

Fastener materials

Good practice dictates the use of non-ferrous materials with regard to fasteners used within rainscreen build-ups and systems. These typically include stainless steels, aluminium and plastics.

Structural fasteners for securing the frame and framing system should be made from austenitic grades of stainless steel such as 304 or 316 or grade dependent upon the location and application.

Aluminium fasteners such as rivets of a suitable aluminium grade and flange size are used within systems primarily on the installation of the façade

Nylons and plastics are also used within rainscreen systems; especially with regards to retention of the rainscreen insulation layer and when in conjunction with a screw set anchor for installation of support brackets.

There are also façade systems on the market that utilise structural adhesives and hook on systems.

The required performance of fasteners should be considered as a part of the initial system specification. A combination of generic test data, system specific testing and on site testing should all be considered by the structural engineer responsible for the system design to ensure that the correct product type is selected to enable calculation of safe working loads and fastener locations and the specific requirements of the system's design criteria and warranty requirements.

The uses and materials are application specific and as such are referenced where appropriate within the specific product categories within this document.

The fastener components can be classified into four key areas:

- 1 Bracket to supporting wall or frame
- 2 Framing system fasteners
- 3 Insulation support anchors and fasteners
- 4 Façade fasteners

1 FASTENING OF SUPPORT SYSTEMS TO STRUCTURE

The type of frame bracket fastener is greatly dependent upon the substrate or frame that the bracket requires to be secured to. The basic substrates are masonry or a framing system; mother substrates can be used.

1.1 Masonry

Masonry substrates can consist of: - concrete dense, aerated or no-fines; brickwork, solid, hollow or perforated; blockwork, solid, hollow or aerated structure. Where an existing structure is concerned the substrate can vary and where a render or other system is applied confirmation of the substrate may be complex. The wall's structural ability to support a rainscreen system and the point loads from brackets needs to be considered especially with regards to an existing structure.

The general fastener types associated with this type of substrate are screw set anchors, which comprise of an engineered nylon expansion plug and stainless steel screw and are available with differing expansion zones and minimum embedment depths to suit the specific substrate. Where more difficult substrates are identified such as weathered stone or other friable materials other anchors may need to be considered such as torque controlled anchors and resin anchors.

All masonry fasteners will require a pilot hole pre-drilled into the substrate prior to installation. It is essential that the product manufacturer is consulted to establish the correct hole size, embedment depth and clamping performance (build up thickness) and that the fastener is suitable for the specific substrate.

Edge distances should also be considered - all these criteria can differ considerably depending upon the actual substrate. Hole preparation should not be overlooked. One of the most common causes of fastener failure in masonry is due to incorrect or lack of cleaning once a pilot hole has been drilled. Manufacturers will reference the method for hole cleaning for each of their own products.

Great care should also be taken to ensure that the existing substrate will offer sufficient performance relevant to the proposed system requirement for fastener performance. This can be determined by on-site pull out testing or generic test data. Again, consult the fastener manufacturer.

Rainscreen fasteners for masonry can generally be split into the following types -

1.1.1 Screw set anchors

Screw set anchors are the most commonly used products for securing rainscreen brackets to a wide variety of masonry substrates.

A screw set anchor consists of a 316 grade stainless steel screw and an engineered nylon plug designed with an expansion zone to suit the embedment depth requirements of the specific anchor to suit the substrate. The nylon expansion plug will have a collar that sits on the face of the rainscreen bracket as the mechanical performance is generated from the combined forces of the fastener and plug.

To ensure that the screw expands the plug correctly during installation a screw set anchor with plugs with torsional protection should be selected.

Screw set anchors are designed to be installed with the screw being screwed into the plug; the manufacturer's installation instructions should be followed.

The screw set anchor should be chosen to suit the masonry substrate type as detailed in the manufacturer's literature or the associated European Technical Approval (ETA), and to suit the performance criteria for the application. On-site testing is recommended to confirm the anchors performance and suitability for the specific substrate.

The screw set anchor design with regards to the diameter plug flange and head style needs to be checked for compatibility with the bracket type being installed and the manufacturer's installation instructions should be followed.

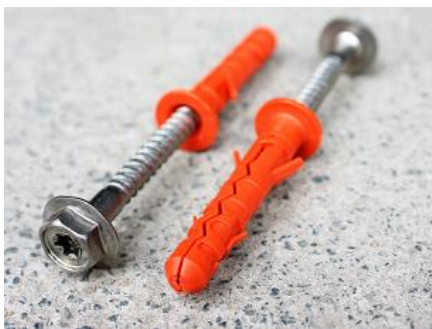

1.1.2 Through bolts and resin anchors

In situations where screw set anchors or thread forming fasteners do not meet the required performance with regard to the technical values achieved, where the substrate is deemed as unsuitable or required edge distances are unachievable, then through bolts or resin anchors should be considered.

Through bolts would generally be specified where a greater shear load is required although their use is limited mostly to concrete with a high compressive strength. Care should be taken to establish the concrete condition with regard to cracked or un-cracked concrete before the appropriate fastener is selected.

For less stable, friable or low compressive strength substrates or where cavities exist within the masonry that cannot be accommodated by a screw set anchor, resin anchors should be considered.

A wide range of resins are available and again great care should be taken when selecting a product. On occasions, a mesh sleeve may be additionally required to ensure the fastener performance meets the required values. As always, seek guidance from the manufacturer and always choose a reputable supplier capable of providing comprehensive technical advice and on-site support when considering using these products.

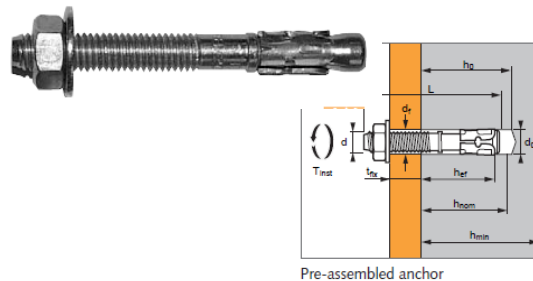

1.1.3 Thread forming fasteners

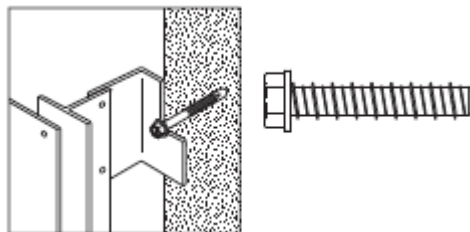

Fasteners are available which are 'self-tapping' and 'thread form' into a pre-drilled hole. The shear, tensile and pull out values should all be considered at the point of design, together with the fastener material which generally will need to be stainless steel or stainless steel bi-metallic self-tapping anchor for aluminium brackets and for longevity of the overall system. Thread forming fasteners are of a smaller diameter generally 6.5mm and 7.5mm than screw set anchors. Thread forming fasteners must have a head size or washer suitable to support the bracket/support section and resist pullover.

This type of anchor is only suitable to substrates that can accommodate a thread forming fastener and produce a matting thread in the substrate and where this matting thread can be retained. Therefore this type of anchor needs to be checked for suitability by the structural/design engineer for the specific system/substrate.

1.2 Steel

1.2.1 Self-drilling fasteners

The most commonly used fastener for fixing rainscreen brackets or primary support rails back to a light steel frame system is a self-drilling fastener. This is generally a bi-metallic fastener comprising of a carbon steel drill point and lead threads welded to a stainless steel threaded fastener.

It is essential when selecting a self-drilling fastener that the pull-out and shear performance of the fastener is suitable to meet the design requirements of the rainscreen system and that the correct length fastener is used to ensure that the stainless steel section of the fastener is engaged into the steel substrate; therefore the manufacturer's published grip/clamping range should be adhered to. Self-drilling fasteners are available with and without a free spin zone. The following factors need to be taken into account:

1 The thickness of the steel to be drilled

Bi-metallic self-drilling fasteners are manufactured with their own integral drill point which is designed to drill and thread form into a pre-determined steel thickness typically in a range up to 12-14mm. If the wrong product is selected for example, a fastener designed for 12mm steel is used into 2.5mm steel, then the performance of the fastener will be dramatically reduced due to the fact that the drill tip will create a much larger hole in the steel which, in relationship to the fastener thread diameter, will result in minimal thread engagement. In reverse, a fastener designed for thin steel used in thick steel will result in either the drill tip 'burning out' or the threads collapsing when the fastener tries to thread form as the hole created is much too small.

2 The build-up thickness or 'clamping range'

As with masonry fasteners, self-drilling fasteners are designed specifically to accommodate a particular build-up range. It is essential that all layers (including voids) between the underside of the fastener head and the backside of the steelwork are calculated; for example a 3mm bracket + 12mm cement particle board + 2.5mm steel would equate to a build-up thickness of 17.5mm. A fastener should therefore be selected with an 'effective thread length' greater than 17.5mm.

The fastener manufacturer should be consulted if there is any doubt; this is to ensure that the carbon steel drill tip is not in contact with any part of the steel work or build up. Once installed all threads above and below the steel should be stainless steel.

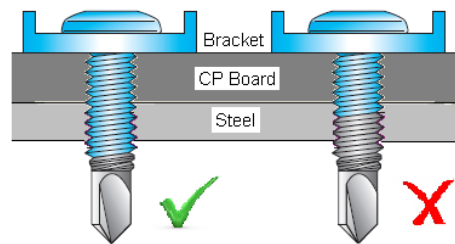

1.2.2 Self tapping screws

On occasions, steel will be too thick for commercially available drill screws to accommodate. In this instance a self-tapping fastener should be selected. Whilst the build-up thickness need not be considered in relation to accommodating the carbon steel drill tip, it is still necessary to consult with the fastener manufacturer regarding the effective working thread length. Thread forms on self-tappers will also vary depending on the thickness of steel to be 'tapped'. Consult the manufacturer for guidance.

With regard to pilot hole diameters - this will be determined by the thickness of the steel in relation to the diameter of the fastener. Good quality drill bits should be used but discarded once they show sign of wear as this will affect the fastener performance.



1.2.3 Composite panels

Increasingly, it is becoming more and more common to fasten rainscreen systems to the face of composite panels. In most cases a structural rivet is the natural fastener choice but through innovation by some manufacturers - self drilling fasteners are available for this application, depending upon the panel type proposed. Whilst manufacturers can provide technical details regarding the fastener performance in the panel, it is strongly recommended that a designed system approach is taken regarding this application and that the panel manufacturer is consulted to ensure that any bracket or rail system fixed to the face will be secure and that the panel type is appropriate for the application/design to ensure panel delamination and system failure is avoided.

1.3 Timber

When fixing to timber, both drill screws and self-tapping screws may be selected depending on the thickness and type of timber to be fixed into. Timber used in construction can generally be split into two types:

- 1 Solid timber, usually used as studwork, often structural.
- 2 Composite board, such as oriented strand board (OSB), plywood or any timber product made up from layers of more than one piece of timber and bonded to form a sheet or structural member such as cross laminated timber (CLT), structural insulated panels (SIP) or Glulam beams.

When fixing into solid timber self-drilling fastener may be selected as the drill tip will form the correct sized pilot hole and so give optimum performance and help stop the timber splitting, or where a self-tapping fastener is used a pilot hole may be required depending upon the type of substrate. When fixing through (or to) timber sheet materials it is advisable to ascertain characteristic pull out values in these less structural boards.

Most manufacturers will advise on minimum embedment and edge distance requirements and in all cases guidance can and should be sought from *BS EN 1995-1-1:2004 + A1:2008 - Eurocode 5; Design of timber structures*.

1.4 Installation tooling

All fasteners should be installed using the manufacturer's recommended installation tool to ensure that the correct installation speed and end loads are used for installation of the selected fastener component. In addition, a depth locator should also be used to eliminate the risk of overdriving which leads to thread stripping. All of the above will affect the performance of the fastener in application which can ultimately lead to loss of function.



2 FASTENING OF RAIL SYSTEMS

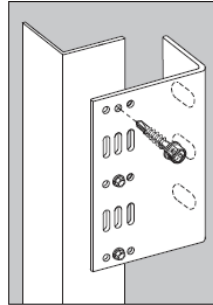

2.1 Aluminium

The vast majority of rainscreen support systems in the United Kingdom will be manufactured from aluminium. As different system manufacturers supply a wide range of alloys from 1050 (soft) - T6-6063 (harder) grade, fastener and system performance can be dramatically affected depending on which alloy is specified or supplied.

Self-drilling fasteners

The choice of fastener and fastener material for aluminium framing system is generally with a wholly austenitic stainless steel self-drilling fastener in 304(A2) or 316(A4).

The fastener should be selected on its drilling capacity to suit the thickness of the aluminium being drilled and the fasteners clamping/grip range to suit the overall combined thickness of the sections being installed. The head style can range from a flanged hexagon to a button headed fastener, depending on the system requirements.

Due to the nature of aluminium it can be easy to overdrive the fastener which can cause 'thread stripping'. To alleviate this problem use a depth locator or a fastener with a free spin zone; however, with a free spin zone this needs to be selected to accommodate the specific material thicknesses being installed.

Too large a free spin zone and the material will not be sufficiently clamped leading to excessive play within the frame leading to rattling and too small a free spin zone the threads will engage into the material and may not be fully supported by the thread.

There are two type of fixing connections required; a fixed connection where two aluminium sections are secured together with the fastener either going into a round hole in the first section to be secured or drilling both sections and a floating/expansion connection where the fastener is installed into a slotted hole in the first section and then drilling and tapping into the second section. The location of fixed and floating points will be determined by the overall design of the framing system.

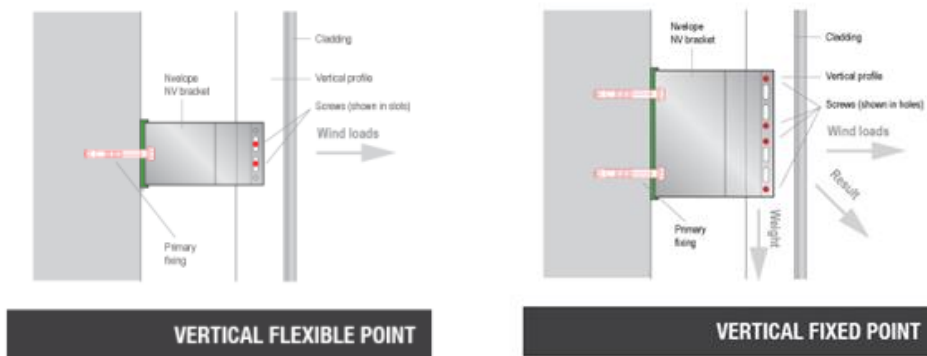

Images courtesy of Nvelope Rainscreen Systems Limited

Rivets

Some framing systems can be installed with a rivet with a stand-off nosepiece. This will effectively clamp the section whilst still allowing the required movement. The obvious downside of this is the requirement to pre-drill the aluminium. The framing manufacturers/designer should be consulted to ensure that a riveted framing system is suitable for the loads of the overall rainscreen system design.



3 FASTENING OF INSULATION BOARDS

It is generally considered that the fixing of insulation boards is a non-structural application. So whilst a less technical approach may be adopted it is worth noting that the insulation will still be subjected to wind loads during construction and that regulations exist concerning wind loads and fire regulations that must be adhered to.

BR 135 (in relation to fire control) states that whilst plastic fasteners may be used for restraining the boards, at least 1 metal fixing should be used per square metre. Generally speaking, on a 1200 x 2400mm board this equates to 9 fixings (min) per board - 3 plastic fasteners down either side and 3 metal fasteners down the centre line.

The fasteners should be no less than 50mm and not more than 150mm from the corners or edges. In addition, where the board may be subjected to external wind pressure, the requirement for additional fasteners should be assessed in accordance with *BS EN 1991-1-4:2005 (UK National Annex to Eurocode 1 Actions on structures, general actions, wind actions)*. Individual insulation manufacturers should always be consulted with regard to fixing patterns.

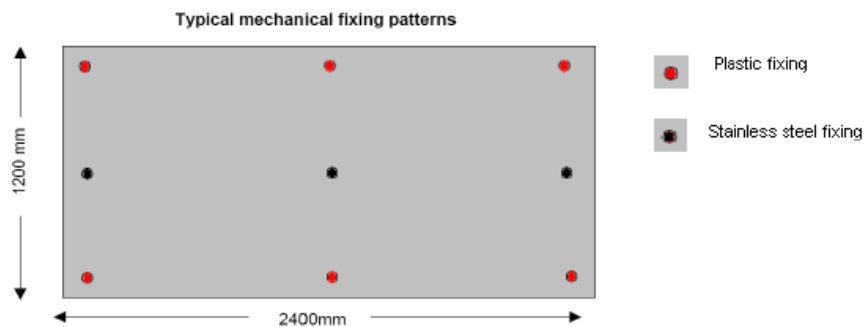

3.1 Insulation to masonry

Typically, a hammer in type fastener will be selected. Depending on the type of insulation being fixed (foam type or mineral wool) will determine the minimum size of head that the fastener should have - a smaller head 25-40mm can be used on most rigid boards whilst a 70-90mm head will be required for softer mineral wool insulation boards.

Best practice recommends that the insulation manufacturer should be consulted for guidance with regard to this. Pilot hole diameters and embedment depths should be acquired from the fixing manufacturer and installation guidance should always be followed exactly.



3.2 Insulation to steel, timber and sheathing board

For these substrates, a plastic or stainless steel disc (fixing pattern as with masonry above) in conjunction with the fastener appropriate to the substrate should be selected. Guidance on fastener selection should be followed as above (see section 2, *Fastening of rail systems*).

It is becoming more common, and in some cases unavoidable, to fix insulation to sheathing boards over steel frame. Best practice recommends fixing through the sheathing board and into the steel/timber structure.

Where this is not possible, it is advisable to ascertain the fastener performance in the sheathing board prior to installation as the different boards available will offer quite dramatic differences in performance regarding resistance to fastener 'pull out'.

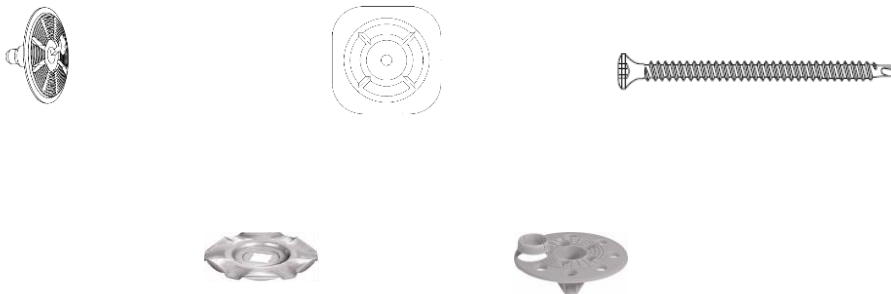

4 FAÇADE FASTENERS

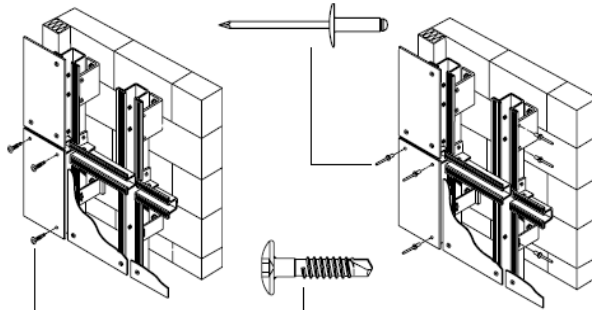

Many façade systems are available in the market ranging from granite, composite stone materials and terracotta tiles to high pressure laminate (HPL) and rainscreen cladding boards, though to aluminium cassette and aluminium composite materials (ACM).

Each system has its own attachment and fastener requirements which can range from specialist undercut anchors, hanging and hook on brackets bracket systems to face or recessed fixed fastener systems.

The specific façade manufacturer's instructions and recommendations should be adhered to with regards the method of attachment. Here we are concentrating of aluminium and ACM panels, for other façade systems please contact the fastener manufacturer or system supplier for specific fastener systems.

4.1 Aluminium and ACM

Generally aluminium and ACM facades systems are secured to an aluminium frame. The main methods of attachment are from either a hook on system which hooks on to specialist brackets or frame sections specifically designed to support the façade.

Some fixed point and/or through fixed points may be included within the overall design at junctions or at capping details.

The main fixing methods for systems that are mechanically fixed are rivets and self-drilling fasteners.

4.1.1 Rivets

Best practice recommends that all panels are prepared with an oversized hole (in relation to the proposed rivet diameter) by the fabricator. This should be calculated on the anticipated expansion of the panel and sub-frame. The rivet which is then selected to fix the panel should be accurately fixed in the centre of the panel hole to ensure that thermal/differential movement between the panel and its supporting structure is accommodated.

The head diameter of the rivet should be of a size suitable to clamp the panel and of a size to ensure that the hole is covered from view even after movement as taken place.

To achieve accurate installation of the fastener, use of a centering tool is recommended. Variations of these tools are available from different manufacturers and offer differing levels of accuracy.

When installing rivets, in addition to the centering tools, a stand-off nose piece should be used. This will hold the rivet off the face of the panel usually by a fraction of a millimetre. This ensures that the panel is securely clamped but not 'locked' as with framing and allows the panel to naturally expand.



Rivet Spacer
Nosepiece



Centralising Tool



Having addressed the issue of allowing movement of the panel whilst securely attaching it to the sub-frame, it must be noted that panels will also require a 'fixed point' to avoid slippage. If all the holes in the panel are oversized and the fastener is 'held off' then the panel will slip.

To overcome this, the system designer should specify fixed points based on his calculations with the fixed point pilot hole diameters being drilled in the appropriate places and clearance holes for the floating point also being drilled in the appropriate places to the designer's requirements.

If no fixed points are allowed that is, all the holes are oversized, then a solution is available. Fixed point sleeves are a simple and effective way to create the required fixed point in an oversized hole. The system designer is responsible for dictating the location and the fastener manufacturer will offer the appropriate sized sleeve to accommodate this.



4.1.2 Self-drilling/self-tapping fasteners

Self-drilling fasteners can also be utilised in the installation of aluminium cassette panels and ACM panels to either aluminium or timber framing systems. The same requirements for fixed and floating point fasteners are required for self-drilling fasteners. Fasteners can be supplied with a centering grommet to provide a floating point.



Some façade systems on the market provide, as with the framing system, slotted holes to accommodate the thermal movement within the system and to accommodate self-drilling fasteners without the need for specialist designed fasteners or for the installer to drill the panel to accommodate the thermal movement.



With all aluminium rainscreen systems always consult the fastener manufacturer or the aluminium system manufacturer prior to installation.

MCRMA RAINSCREEN GROUP

The Rainscreen Group, formed from companies within MCRMA membership, includes the principal companies who supply metal based systems and component parts used within the fabrication and construction of rainscreen cladding systems.

Members of the group have been involved in the development of rainscreen systems over many years and have an extensive knowledge of their use and application on all types of buildings. In addition, the Rainscreen Group provides a technical focus for specifiers who wish to use these highly aesthetic systems on prestigious new build developments or refurbishment projects.

Members of the Rainscreen Group speak with authority on the subject, provide support based on years of knowledge and give reliability in the systems they supply and manufacture. For more information visit <http://www.mcrma.co.uk/rainscreen.htm>

DISCLAIMER

Whilst the information contained in this publication is believed to be correct at the time of publication, the Metal Cladding and Roofing Manufacturers Association Limited and its member companies cannot be held responsible for any errors or inaccuracies and, in particular, the specification for any application must be checked with the individual manufacturer concerned for a given installation.

Information provided by the MCRMA or contained within publications and articles which are made available in any form (mechanical, electronic, photocopying or otherwise) cannot be used or cited as a means of ensuring that a material, product, system or assembly is compliant with Building Regulations.